



ASAMI®

Owner's Manual

Original Instructions

Commercial Air Conditioners

Multi-VRF Centralized Controller

Model:

CE53-24/F(C)

To Users

Thank you for selecting Gree's product. Please read this instruction manual carefully before installing and using the product, so as to master and correctly use the product. In order to guide you to correctly install and use our product and achieve expected operating effect, we hereby instruct as below:

- (1) This appliance is not intended for use by persons (including children) with reduced physical, sensory or mental capabilities, or lack of experience and knowledge, unless they have been given supervision or instruction concerning use of the appliance by a person responsible for their safety. Children should be supervised to ensure that they do not play with the appliance.
- (2) This instruction manual is a universal manual, some functions are only applicable to particular product. All the illustrations and information in the instruction manual are only for reference, and control interface should be subject to actual operation.
- (3) In order to make the product better, we will continuously conduct improvement and innovation. We have the right to make necessary revision to the product from time to time due to the reason of sales or production, and reserve the right to revise the contents without further notice.
- (4) For personal injury or property loss and damage caused by improper operation such as improper installation and debugging, unnecessary maintenance, violation of related national laws and rules and industrial standard, and violation of this instruction manual, etc., we will bear no liability.
- (5) The final right to interpret for this instruction manual belongs to Gree Electric Appliances Inc. of Zhuhai.

Contents

1 SAFETY NOTICES (PLEASE BE SURE TO ABIDE)	1
2 USER NOTICE	1
3 INSTALLATION	2
3.1 INSTALLATION REQUIREMENTS	3
3.2 WIRING INSTRUCTIONS	4
3.3 WIRING INSTRUCTIONS	8
3.4 REMOVAL PROCEDURE	9
4 DISPLAY AND WORKING INSTRUCTIONS	10
4.1 MAIN PAGE DISPLAY AND BUTTONS	10
4.2 GENERAL BUTTONS	11
4.3 BUTTONS WORKING INSTRUCTIONS	11
5 FUNCTIONS DESCRIPTION	13
5.1 ALL ON/OFF	13
5.2 SINGLE UNIT CONTROL	13
5.3 WATER/FLOOR CONTROL	17
5.4 FRESH AIR CONTROL	21
5.5 E-CONTROL FUNCTION	23
5.6 GROUP CONTROL	24
5.7 SCHEDULE MANAGEMENT	26
5.8 LOCAL SETTING	28
5.9 ENGINEERING SETTING	30
5.10 OPERATION NOTICE	31
6 ROOM VIEW	31
6.1 ALL ON/OFF	32
6.2 ROOM CONTROL	32

1 Safety Notices (Please be sure to abide)



Warning: If not abide strictly, it may cause severe damage to the unit or the people.



Note: If not abide strictly, it may cause slight or medium damage to the unit or the people.



This sign indicates that the operation must be prohibited. Improper operation may cause severe damage or death to people.



This sign indicates that the items must be observed. Improper operation may cause damage to people or property.



WARNING!

This product can't be installed at corrosive, inflammable or explosive environment or the place with special requirements, such as kitchen. Otherwise, it will affect the normal operation or shorten the service life of the unit, or even cause fire hazard or serious injury. As for above special places, please adopt special air conditioner with anti-corrosive or anti-explosion function .

2 User Notice

- ◆ All indoor units must be supplied with unified power.
- ◆ Make sure communication cord is connected with the proper port, otherwise there may occur communication malfunction.
- ◆ Never knock on, throw or frequently detach the centralized controller.
- ◆ Never operate the centralized controller with wet hands.
- ◆ Never scratch the screen of centralized controller by hard or sharp objects.
- ◆ If the centralized controller is connected with the outdoor network or the last indoor unit of the indoor network, then a matching resistance must be connected between G1 and G2 ports.

3 INSTALLATION

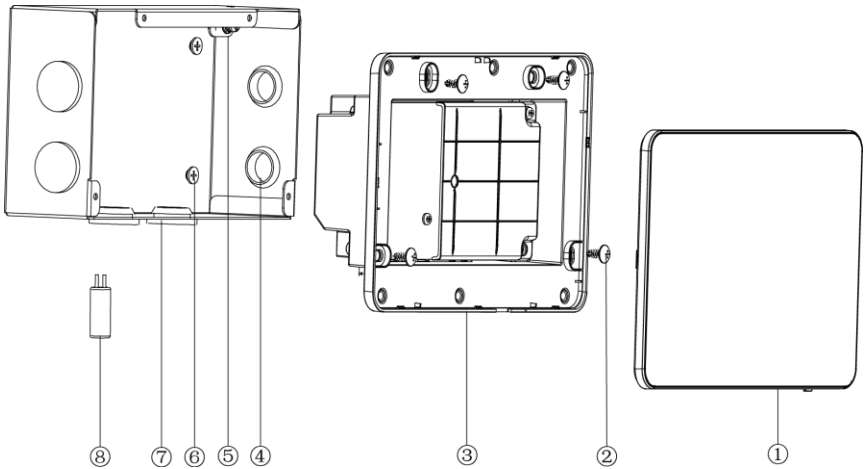

Fig.3.1 Parts of Centralized Controller

No.	①	②	③	④
Name	Touch screen	Self-tapping screw ST4.2×9.5 MC (used to secure the rear cover of controller)	Rear cover of controller	Rubber band
QTY	1	4	1	6
No.	⑤	⑥	⑦	⑧
Name	Screw M4×12 (used to secure ground wire)	Screw ST4.2×16 FA (used to secure electric box cover)	Electric box cover	Matching resistance
QTY	1	4	1	1

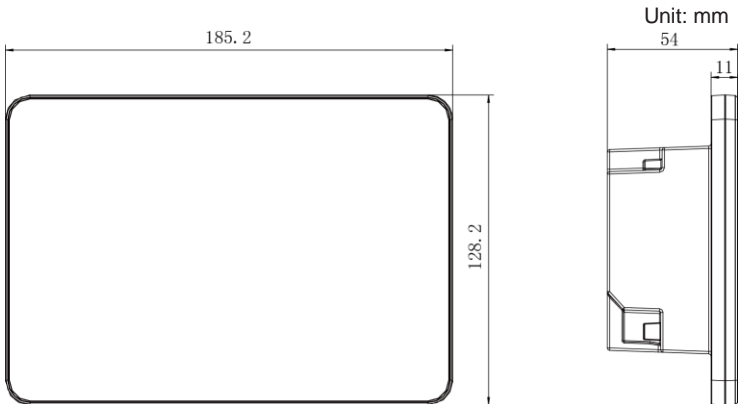

Fig.3.2 Dimension of Centralized Controller

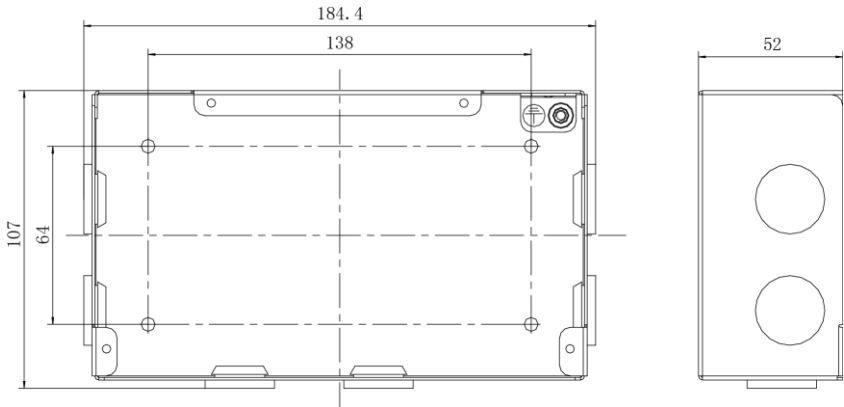

Fig.3.3 Dimension of Electric Box Cover

3.1 Installation Requirements

(1) Communication cord of the centralized controller must be selected according to the table below. Never use the cable that is not in compliance with instructions of this manual.

Network	Cord type	Cord standard	Cord size (mm ² /AWG)	Total length L(m/feet)	Remark
Indoor network	Light/Ordinary polyvinyl chloride sheathed cord. (60227 IEC 52 /60227 IEC 53)	IEC 60227-5:2007	2×0.75~2×1.25 (2×AWG18~2×AWG16)	L≤1000m (L≤3280-5/6feet)	If cord size is 2×1mm ² (2×AWG16), communication cord can be stretched longer. But the total length can't exceed 1500m(4921-1/4feet). Total length of communication cord can't exceed 500m(820-1/5feet).
Outdoor network				L≤500 (L≤820-1/5feet)	



Notice:

- ① The cord shall be Circular cord (the cores shall be twisted together).
 - ② If unit is installed in places with intense magnetic field or strong interference, it is necessary to use shielded wire.
- (2) Never install the centralized controller in the following places:
- 1) Places with corrosive gas or serious dust, salt mist or oil smoke.
 - 2) Wet and damp places, with direct sunlight.
 - 3) Places near high temperature objects or places where units might be splashed by water.

3.2 Wiring Instructions

(1) Wiring Ports

Port print	G1, G2	F1, F2	A2, B2	A3, B3	L, N
Meaning	CAN comm. port	【reserved port】	【reserved port】	【reserved port】	Power port

(2) Power Supply

The smart centralized controller shall use independent power supply.

The range of input voltage: 100~240 VAC; Frequency range: 50/60Hz

Select power cord according to the following table. Never use the power cord that is not in compliance with instructions of this manual.

Cord type	Cord standard	Cord size (mm ²)
Single-cord soft conductiveunsheathed cord (60227 IEC 08)	IEC 60227-3:2007	1.5

(3) Connection Method

There are three methods to connect centralized controller with the air conditioning system.

Method 1: Connect with indoor network

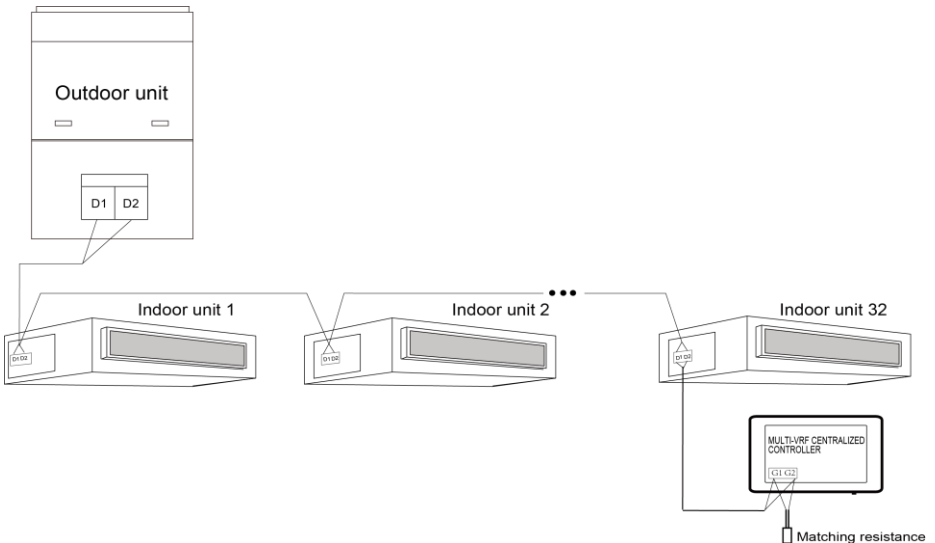

Fig.3.4 Centralized Controller Connected with Indoor Network

Method 2: Connect with outdoor network

Multi-VRF Centralized Controller

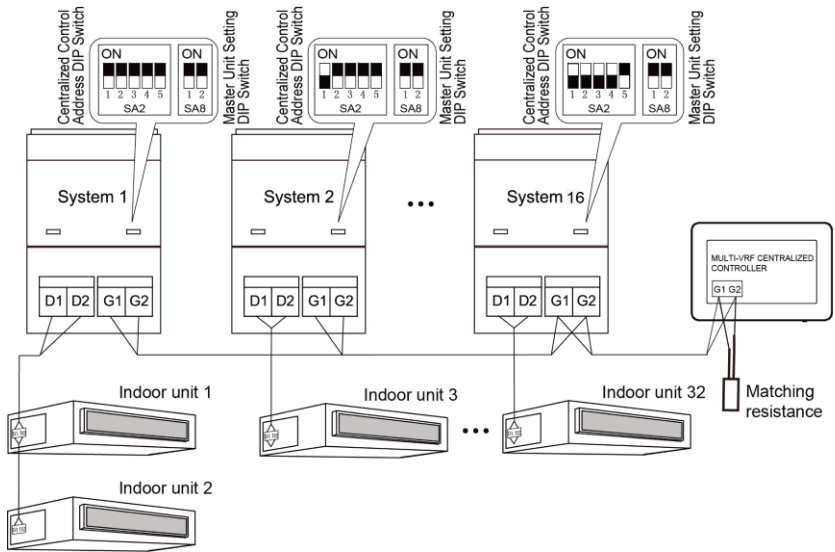

Fig.3.5 Centralized Controller Connected with Outdoor Network

Method 3: Connect with heat recollection mode converter Network

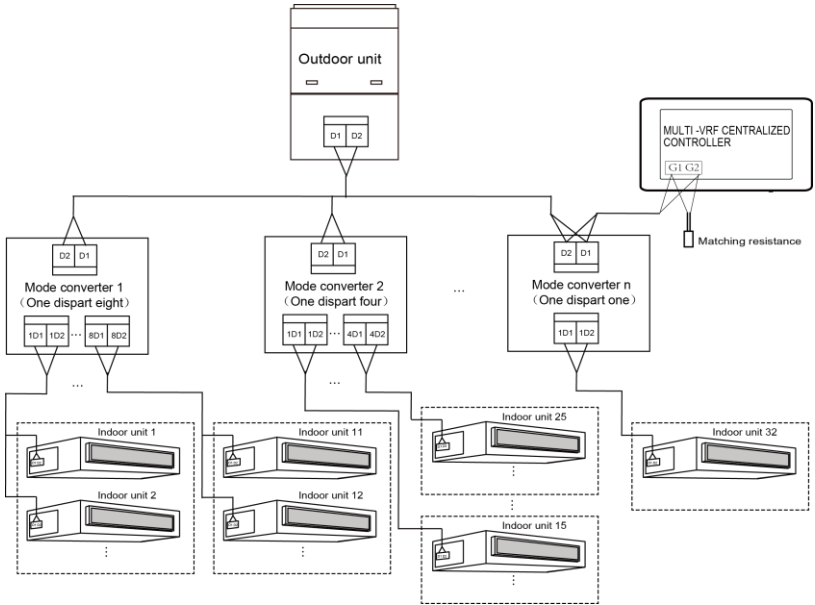

Fig. 3.6 Centralized Controller Connected with Heat Recollection Mode Converter Network

Wiring Instructions:

- ① The smart centralized controller is applicable to multi VRF units, connectable with network of indoor units or the network of outdoor units or mode converter network. One centralized controller can control up to 16 sets of outdoor system and up to 32 sets of indoor unit.
- ② If the centralized controller is to be connected with the network of indoor units, connect according to fig.3.4. The controller can connect with any one indoor unit in series, that is, connect the controller's G1 and G2 ports with the D1 and D2 ports correspondingly with communication cords. When the controller is connected with the terminal unit of indoor network, a matching resistance needs to be added with the communication cords at the G1 and G2 ports.
- ③ If the centralized controller is to be connected with the network of outdoor units, connect according to fig.3.5. The centralized controller can only be connected with the terminal system of the outdoor network. A matching resistance needs to be added with the communication cords at the G1 and G2 ports.
- ④ The centralized control address DIP switch (SA2_Addr-CC) indicates the centralized control address required when different refrigerating systems are controlled in a centralized manner. The default factory setting is "00000".
- ⑤ If the centralized controller is to be connected with the network of heat recollection, connect according to Fig. 3.6. The method 2 is also applicable to centralized controller switching in heat recollection network.

If the centralized controller is to be connected with the network of outdoor units, set the DIP switch according to the following methods:

- 1) The DIP switch must be set on the master unit and set the Master Unit Setting DIP Switch(SA8) to "00".Otherwise, the setting is invalid.
- 2) On the same refrigerating system, the centralized control address DIP switch (SA2_Addr-CC) on a non-master unit is invalid, and it is unnecessary to change the settings.
- 3) The centralized control address DIP switch (SA2_Addr- CC) on the master unit of a refrigerating system must be set to "0000/", and this system is the master system.
- 4) The centralized control address DIP switch (SA2_Addr- CC) on the master unit of other refrigerating systems must be set as follows:

Note: The centralized control address switch of DIP5 invalidation

SA2					Address NO.
DIP1	DIP2	DIP3	DIP4	DIP5	
1	0	0	0	/	2
0	1	0	0	/	3
1	1	0	0	/	4
0	0	1	0	/	5
1	0	1	0	/	6
0	1	1	0	/	7
1	1	1	0	/	8
0	0	0	1	/	9
1	0	0	1	/	10
0	1	0	1	/	11
1	1	0	1	/	12
0	0	1	1	/	13
1	0	1	1	/	14
0	1	1	1	/	15
1	1	1	1	/	16

- 5) The centralized control address DIP switch (SA2_Addr- CC) cannot be the same between different refrigerating systems. Otherwise, address conflicts may occur and the unit cannot run properly.
- 6) If the address conflict occurs, it will popup the address conflict page.

Note:There are three ways to solve address conflict.

- 1: Enter into an unoccupied address by manually for the conflict address, the address conflict can be solved after it set up success.
- 2: Press and hold the “Save” button for 5 seconds on the address conflict page, select reset all the IDU’s address in the system, after entering the engineering password, system will reassign all the address.
- 3: On the master unit of master system, press “SW3” to enter the to-be-selected status of function settings, press “SW1 (UP)” or “SW2 (DOWN)” to select the function of “n5”, press “SW7” to enter “n5” function settings, press “SW7” again to send the project number offset command.

3.3 Wiring Instructions

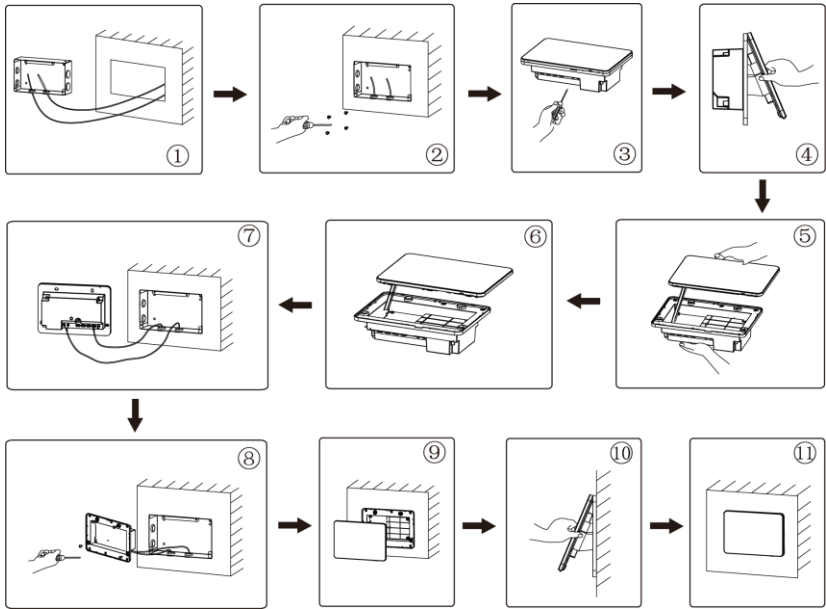

Fig.3.7 Installation Diagram

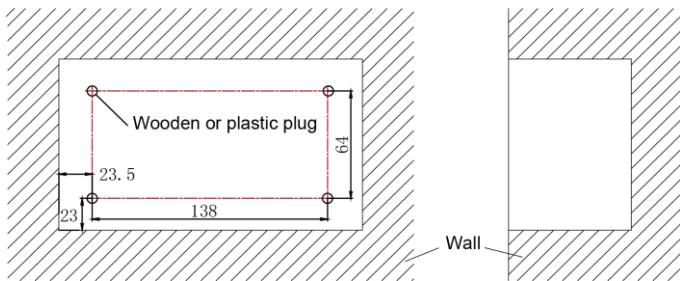

Fig.3.8 Diagram of Wooden or Plastic Plug

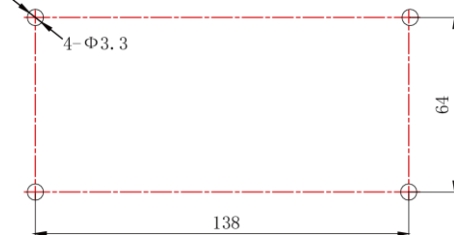

Fig. 3.9 Installation Holes of the Electric Box Rear Cover

Fig.3.7 is a simple installation procedure of centralized controller. Please pay

Multi-VRF Centralized Controller

attention to the following matters:

- (1) Before installation, first cut off the power supply of indoor unit. The power must be cut off during the whole installation process.
- (2) During the installation, be careful not to damage to touch screen.
- (3) Before installation, please make the following preparations:
 - 1) In case that the centralized controller is installed on wall, dig a hole that is the size of $180\text{mm} \times 107\text{mm} \times 62\text{mm}$ and peg 4 wooden or plastic plugs on the wall according to fig.3.8.
 - 2) In case that the centralized controller is installed inside the control cabinet, dig 4 installation holes on the surface of the control cabinet according to fig.3.9.
- (4) In step (1), pull out the power core and communication cord, and then lead them separately from the wire orifice of the electric box rear cover. Never lead the cords through a same orifice.
- (5) In step (2), locate the electric box rear cover to the installation holes of the wall with screw $\text{ST}4.2 \times 16 \text{ FA}$.
- (6) In step (6), pull out the wire connecting the touch screen and controller's rear cover. Put the touch screen on a safe place.
- (7) In step (7), connect the communication cords to G1, G2 terminals, and connect the neutral wire and live wire to the N, L terminal; connect the ground wire to position ⏏ on the electric box rear cover. Secure it with screw $\text{M}4 \times 12$.
- (8) In step (8), locate the controller's rear cover onto the electric box rear cover with screw $\text{ST}4.2 \times 9.5 \text{ TC}$.
- (9) In step (9), connect the wire between touch screen and controller's rear cover.

3.4 Removal Procedure

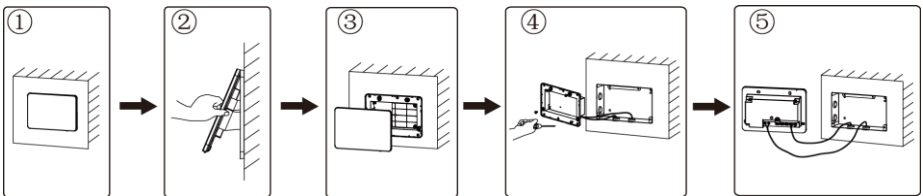

Fig.3.10 Diagram of Removal

4 DISPLAY AND WORKING INSTRUCTIONS

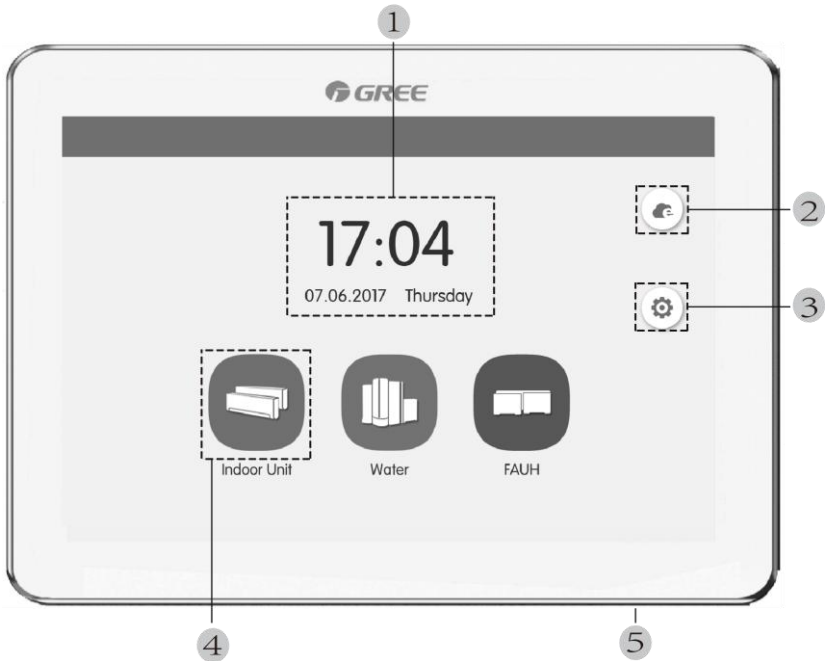















Fig.4.1 Main Page

4.1 Main Page Display and Buttons

No.	Name	Instructions
1	Time zone	The present date, week and time
2	e-Control button 	Press this button to enter e-Control page
3	Setting button 	Press this button to enter setting page
4	Unit button	Press this button to enter IDU page or Water/Floor page
5	Touch button	<ul style="list-style-type: none"> ● Press the Touch Button to turn on/off the screen of centralized controller. ● Press and hold the Touch Button for 5sec to restart to centralized controller.

4.2 General Buttons

Display	Name	Meaning	Display	Name	Meaning
	Return	Press this button to return to the previous page		Cancel	Press this button to cancel the current setting and return to the previous page
	Save	Press this button to save the current setting and return to the previous page		Add	Press this button to add group or schedule
	Edit	Press this button to edit the e-Control,group or schedule		Delete	Press this button to delete group or schedule
	Up	Press this button to increase value or select the previous option		Down	Press this button to decrease value or select the next option
	Group Control	Press this button to enter Group control page		IDU Sort	Press this button to enter IDU sort page
	Add IDU	Press this button to enter Add IDU page		Info	Press this button to enter Info page

4.3 Buttons Working Instructions

The centralized controller uses a capacitive touch screen so that user can operate the units by just touching the screen.

Buttons on the screen are presented in the following ways:

(1) Icon

Icon button can be operated directly. See section 4.2 for more details.

(2) Icon + Text

According to the meaning of Text, turn on or off or select a certain function, or enter a certain page. This type of button has 2 or 3 kinds of status based on the specific function.

Meaning of status (take Sleep Button as an example):



Thin light indicates invalid/not selectable. Sleep function is invalid and can't be selected. Different cases for models.



Light indicates off/not selected. Sleep function is off. Pressing the grey sleep button can turn on the sleep function.



Dark indicates on/selected. Sleep function is on. Pressing the orange sleep button can turn off the sleep function.

(3) Sliding

Sliding left/right or up/down can turn over the page. For example the home page list of indoor units, schedule, etc.

(4) Sliding bar

Press and hold the sliding bar to drag up/down or left/right and to adjust the value. For example the fan speed setting, backlight setting, etc.

(5) Zone button

On the management pages of e-Control functions and schedule, as indicated in fig.4.2 (the home page of schedule), each rectangle frame constitutes a zone button.

Press the zone button, then the turning on/off of corresponding function or the corresponding page will pop in.

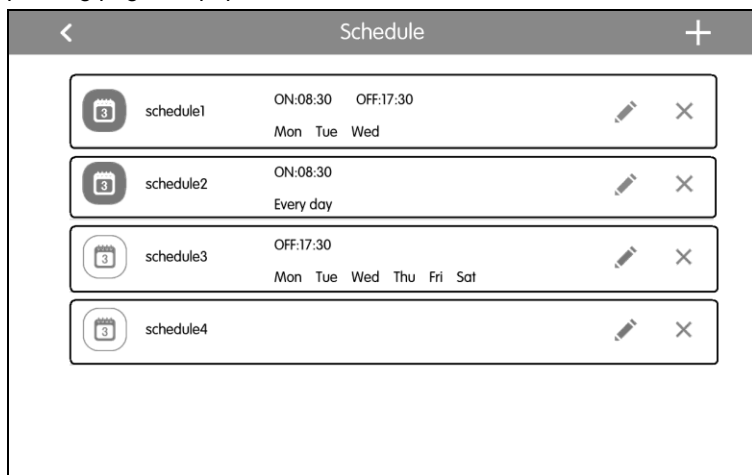

Fig.4.2 Zone Buttons on the Group Control Page

5 FUNCTIONS DESCRIPTION

5.1 All ON/OFF

On the home page, press the “Indoor Unit” button to enter IDU home page, switch to “ALL IDU” option, press the “GroupOFF” button to turn off all indoor units.

Also press the “GroupON” button to turn on all indoor units. Then indoor units will work according to memory.

5.2 Single Unit Control

On the IDU home page, press the icon of indoor unit to enter the single unit control.

Press the icon of indoor unit for 5 seconds to pop up the name set of the selected indoor unit.

Parameters of single unit control include parameters of general control and advanced control.

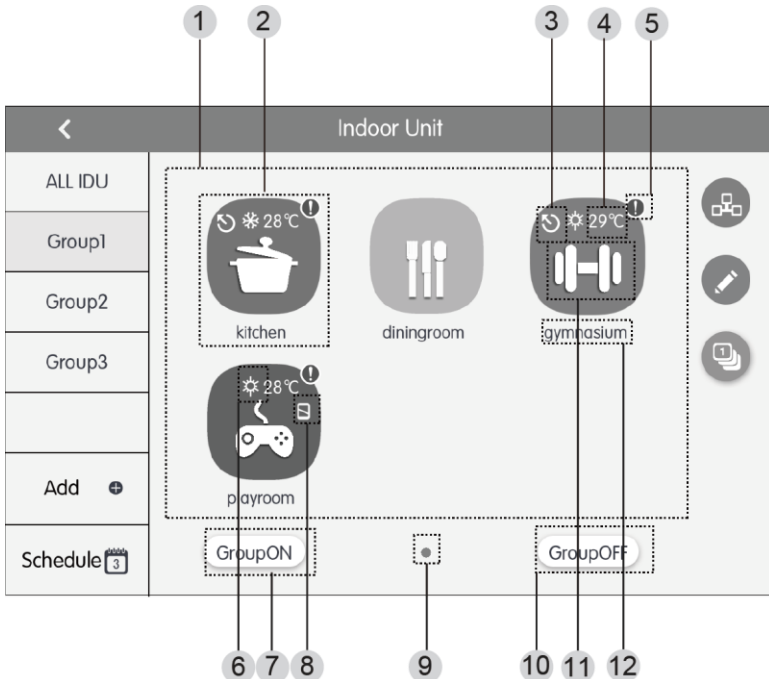

Fig.5.1 Page of IDU home page

Multi-VRF Centralized Controller













No.	Name	Instructions
1	IDU display	Display in separate page the list of indoor units that are controlled by the centralized controller. Sliding left or right can turn over the page.
2	IDU icon	<ul style="list-style-type: none"> ● Press the button to enter the page of indoor unit control. ● Light icon indicates that IDU is on while the dark icon indicated that IDU is off.
3	Master IDU	This icon will be displayed when indoor unit is the master indoor unit of the system.
4	Set temperature	When indoor unit is on, set temperature will be displayed here.
5	Error status	Error icon will be displayed if indoor unit is malfunctioning.
6	Operation mode	<p>When indoor unit is on, the current operation mode will be displayed:</p> <p>  Auto  Cooling  Dry  Fan  Heating  Floor heating  Space heating  3D heating  Refreshing  Absence  Auto dry  Dry Cloth </p>
7	Group on button	Press this button to turn on all air conditioning equipment of the group.
8	Shield status	This icon will be displayed when indoor unit is in shield status.
9	Current page	The total pages of the controlled indoor unit and the current page.
10	Group off button	Press this button to turn off all air conditioning equipment of the group.
11	IDU icon	Display the icon of the indoor unit.
12	IDU name	Display the name of the indoor unit.



Fig.5.2 Page of Single IDU Control

(1) General Control Parameters

1) On/off

Press the on/off button to turn unit on or off.

When unit is turned off, mode, temperature, fan speed and swing can't be set.

2) Mode setting

Press the Mode buttons to set unit's operation mode.

Modes for indoor units of different series are not all the same.

If a certain mode is not available in the indoor unit, the icon of the corresponding mode cannot be selected.

Note:

- ① Only master indoor unit can set auto mode; absence mode can be set only when one indoor unit is turned on and this indoor unit shall be the bedroom indoor unit with three refrigerant pipes.
 - ② Heat recollection system have no master indoor unit. When the indoor unit of the same branch is connected into one indoor unit, the auto mode can be set; when the quantity of indoor unit in the same branch is more than one set, the auto mode cannot be set; other modes can be freely switched.
- #### 3) Temperature setting

Press the up or down buttons to adjust temperature. Each time pressing the button will increase/decrease the temperature by 1. Holding down the button can increase/decrease temperature continuously.

Pressing the **i** button can display the “indoor temp” and “outdoor temp”.

Note:For Bedroom IDU, Press the up or down buttons to adjust temperature. Each time pressing the button will increase/decrease the temperature by 0.5.

4) Humidity setting

Press temperature and humidity switching button to switch to the humidity setting interface. Press the up or down button to adjust humidity. Each time pressing the button will increase/decrease the humidity by 5%. Holding down the button can increase/decrease humidity continuously within the range from 45% to 65%.

Note: Humidity Setting function is particular for Bedroom air condition. other air condition without Humidity Setting function.

5) Fan speed setting

Press or drag the fan speed bar to set unit's fan speed.

Note: Unit defaults to low fan speed in dry mode. Fan speed cannot be set in drying or floor heating mode.

Auto fan speed is defaulted in absence mode and fan speed cannot be set; low fan speed is defaulted in auto dry mode and cannot be set; high fan speed is defaulted in clothes drying mode and cannot be set.

6) Swing setting

Pressing the button “Up-Down Swing” or “Left-Right Swing” can turn on or off the swing function.

Note: Swing types for indoor units of different series are not all the same.

7) Malfunction View

When indoor unit fails to function well, press the **i** button to view the information of malfunctions.

(2) Advanced Control Parameters

Press Advance Button to enter the advance page.

Press icon buttons to turn on or off the corresponding function.

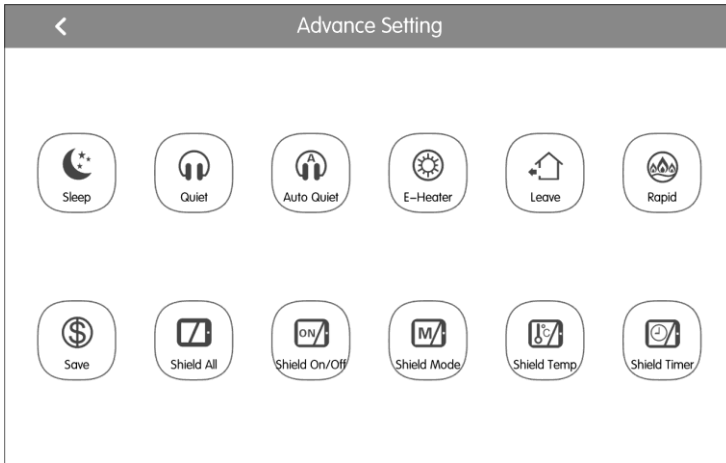



Fig.5.3 Advance Page

- 1) Functions of Sleep, Quiet, E-Heater, Absence and Rapid can only be effective when unit is turned on.
- 2) When sleep function is on, quiet function will be turned on subsequently. Sleep function will not be effective under auto, fan or floor heating mode.
- 3) Absence function can only be turned on in heating mode. When absence function is on, set temperature is 8°C.
- 4) Rapid cool function can only be effective in cool mode. Likewise, rapid heat function can only be effective in heat mode.
- 5) When shield all function is on, other shield buttons will be invalid.
- 6) When Shield Temp function is on, Sleep function is off.

5.3 Water/Floor control

On the water/floor home page, press the icon of water/floor unit to enter the water/floor control interface. Press the icon of water/floor unit for 5 seconds to pop up the name set of the selected indoor unit.

Water/Floor control parameters include water heating control parameter and floor heating control parameter. It can be switched via  button.

Notes:

- ① When there is only one function can be selected (water or floor), it can only display the water heating or floor heating function interface, and cannot be switched to another interface;
- ② Only when it is connected to hot water generator, water heating and floor heating functions are applicable, the interface can be switched and

displaced according to the above instructions;

5.3.1 Water Control Parameter

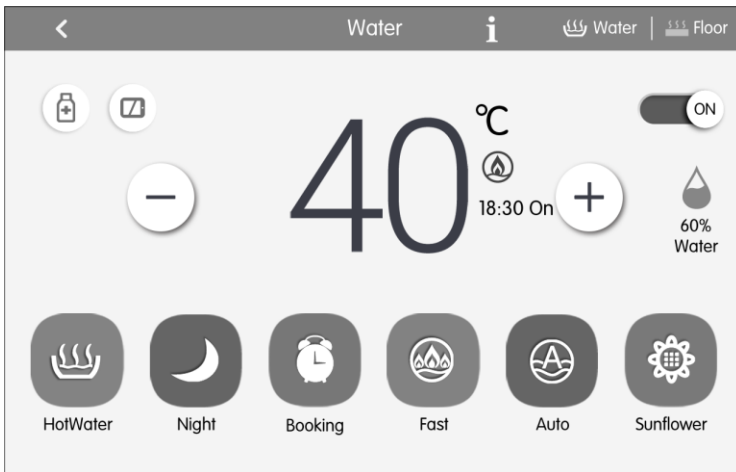

Fig. 5.4 Page of Water heating Control

(1) On/Off

Press the on/off button to turn unit on or off.

When the unit is off, it cannot set the mode, temperature and preset function, while it can set the sterilization function.

(2) Mode Setting

Press the Mode buttons to set unit's operation mode.

There are three modes: HotWater, Booking, Night. These three modes can not be simultaneously conducted, it can only choose one of the modes.

HotWater mode: the water tank or hot water generator will start up or stop heating water according to the current set water temperature.



Booking mode: book the water heating time, the water tank or hot water generator will start up the unit in advance according to the actual water temperature, and will decide the on and off of water tank or hot water generator according to the temperature difference between actual water temperature and the setting water temperature. The water tank or hot water generator will close down the unit 1~4 hours later after the preset time. Once this mode is set, it will circularly operate every day.

Night mode: the fixed period for providing hot water is from 00:00 to 06:00, the

Multi-VRF Centralized Controller

water tank or hot water generator will start up in this period, and will decide the on and off of water tank or hot water generator according to the temperature difference between actual water temperature and the setting water temperature. If it is not within this period, the water tank or hot water generator will close down the unit. Once this mode is set, it will circularly operate every day.

(3) Temperature Setting

It displays the current temperature of hot water as default. The temperature value will turn to the setting temperature and can be adjusted by pressing  and  buttons; the temperature value will increase or decrease by every pressing the button for once. The temperature value will be continuously increased or decreased by long pressing the button. After 5 seconds without any action, the temperature value will turn back to the current temperature.

Under the standard HotWater, Booking and Night modes, the temperature setting range is: 35°C ~ the maximal adjustable temperature 55°C, the acquiescence maximal temperature is 50°C.

(4) Available Hot Water Volume



The water volume can be display in real time, there are five sections of water volume: 100%, 80%, 60%, 40%, 20%, when the water volume is less than 20%, it will flicker.

(5) Function Setting of Water Heating

Under on/off status of water heating, the following functions can be set:



Water On/Off	Functions
Start-up Water mode	Sunflower, Auto, Sterilization, Fast, Shield
Start-up Booking mode	Auto, Sterilization, Fast, Shield
Start-up Night mode	Auto, Sterilization, Fast, Shield
Water heating off	Sterilization

Sunflower function: find the highest outdoor temperature by recording the history data of outdoor temperature to define the time to heat the water, so as to achieve energy saving.

Auto function: the setting temperature of water heating will be automatically provided by water heater according to the outdoor ambient temperature, there is no need to set by the user, and the water temperature cannot be adjusted via  or  buttons.

Sterilization function: it will conduct high temperature sterilization when the water temperature in the water tank is heated to 65~70°C (adjustable) within the

required set time. Press the  button to enter the sterilize page, when the high temperature sterilization is set to be “once”, then the sterilization will be valid for once; when the high temperature sterilization is set to be “circular”, the sterilization will be circularly valid, then it can set the circulated days and presetting sterilization time. When the sterilization function is activated, the icon will flicker.

Fast function: start up the compressor and electric heating water under the allowable conditions of outdoor unit, it displays , the fast water heating function can be set to be valid for once, when the water tank/hot water generator has reached to heat preservation status, it displays , the fast water heating function will be cancelled for energy saving. After the water heating is closed down, the fast water heating function is cancelled.

Shield function: it can conduct shield function by pressing  of wired controller to nullify such operation.

(6) Malfunction View

When the water heater fails to function well, press  to view the information of malfunctions.

5.3.2 Floor control parameter

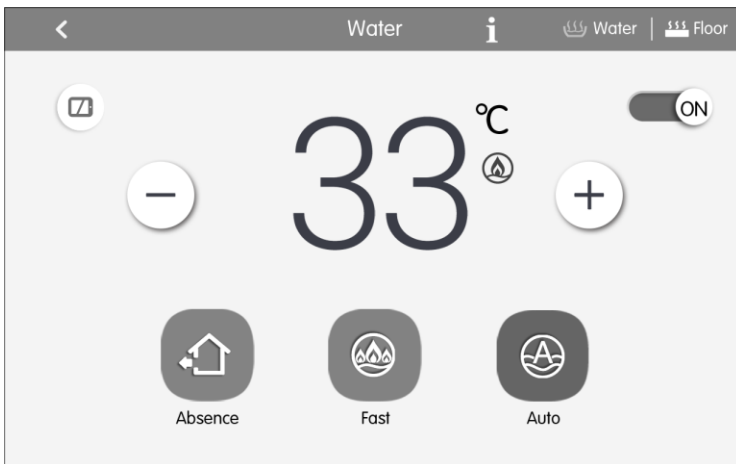

Fig. 5.5 Page of Floor Heating Control



(1) On/off

Press the on/off button to turn unit on or off.

When the unit is off, the mode and temperature cannot be set.

(2) Temperature Setting

Multi-VRF Centralized Controller



It displays the current water yielding temperature as default. The temperature value will turn to the setting temperature and can be adjusted by pressing  and  buttons; the temperature value will increase or decrease by every pressing the button for once. The temperature value will be continuously increased or decreased by long pressing the button. After 5 seconds without any action, the temperature value will turn back to the current water yielding temperature.

Floor heating water yielding temperature range: 25 °C ~the highest water yielding temperature of floor heating 45 °C.

(3) Function Setting of Floor Heating

Under the on/off status of floor heating, the functions can be set as below:

Floor on/off	Function	Remarks
Floor on	Auto, Fast, Absence, Shield	
Floor off	Absence	It will be valid only when the indoor unit is set together with shunt valve

Auto function: the floor heating water yielding temperature will be automatically provided by hot water generator according to the outdoor ambient temperature, there is no need to set by the user, and the water temperature cannot be adjusted via  or  buttons.

Fast function: start up the compressor and electric heating under the allowable conditions of outdoor unit.

Absence function: when the user is absence, it will maintain certain degree of water temperature to prevent the pipelines from being frozen up and prevent the indoor equipment from being destroyed.

Shield function: it can conduct shield function by pressing  of wired controller to nullify such operation.

(4) Malfunction View

When the floor heating fails to function well, press  button to view the information of malfunctions.

5.4 Fresh Air Control

On fresh air homepage, press the fresh air icon for 5 seconds to pop up the fresh air name, project number and icon settings; click fresh air icon to enter fresh air control interface.

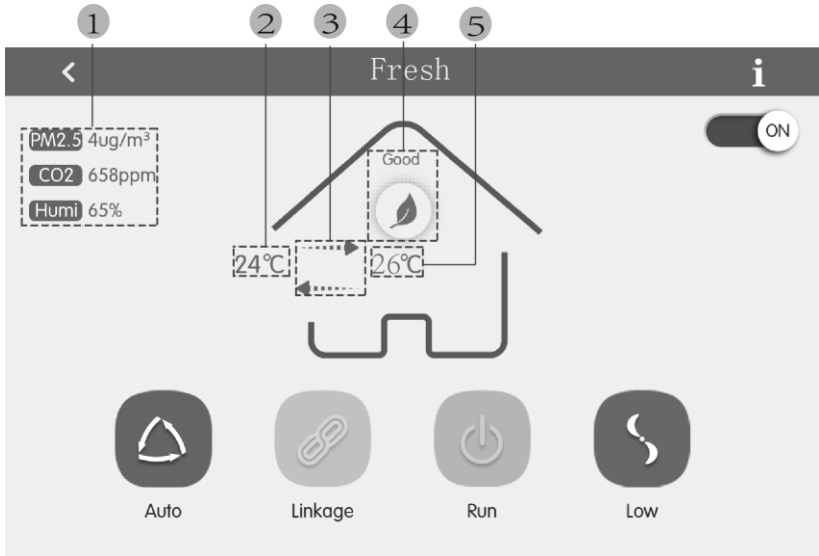

Fig. 5.6 Page of Fresh Air Control

No.	Name	Instruction
①	Parameter display zone of air box	<ul style="list-style-type: none"> ● Display indoor PM2.5, CO₂ and humidity. “- -” will be displayed when air box is not connected ● Upper and lower limits of PM2.5, CO₂ and humidity display keep the same as those in Section 6.2.5
②	Fresh air inlet temperature	Display fresh air inlet temperature
③	Unit operation mode	<ul style="list-style-type: none"> ● Means bypass mode or low temperature mode ● Means discharge mode ● Means heat exchange mode
④	Air quality class	Air quality is classified into six classes, which are excellent, good, moderate, bad, heavy pollution, serious pollution
⑤	Return air inlet temperature/fresh air outlet temperature	Display fresh air return temperature/fresh air outlet temperature

(1) On/Off

Press On/Off button to turn on or turn off the unit.

When the unit is off, mode and fan speed cannot be set. Operation mode and inlet fresh air temperature are not displayed.

Multi-VRF Centralized Controller

Note: The fresh air unit which is connected with air box will display PM2.5, CO₂, indoor humidity and air quality class; when air box is not connected, PM2.5, CO₂ and indoor humidity will display “- -”. Air quality class will be concealed.

(2) Mode setting

Press Mode button to set control mode.

Note: Only the fresh air unit which is connected with air box can set auto mode. The fresh air unit which is not connected with air box cannot select auto mode.

(3) Fan speed setting

Click Fan Speed button to set fan speed.

Note: Auto fan speed can be selected only in auto mode.

(4) Error inquiry

When fresh air unit occurs error, click  to check detailed error information.

5.5 e-Control Function

On the home page, pressing e-Control button can enter the page of e-Control.

e-Control includes 5 short-cut modes (Sleep, Bath, Home, Leaving and Stay out) and 3 DIY modes.

User may reset the functions of different modes according to actual needs.

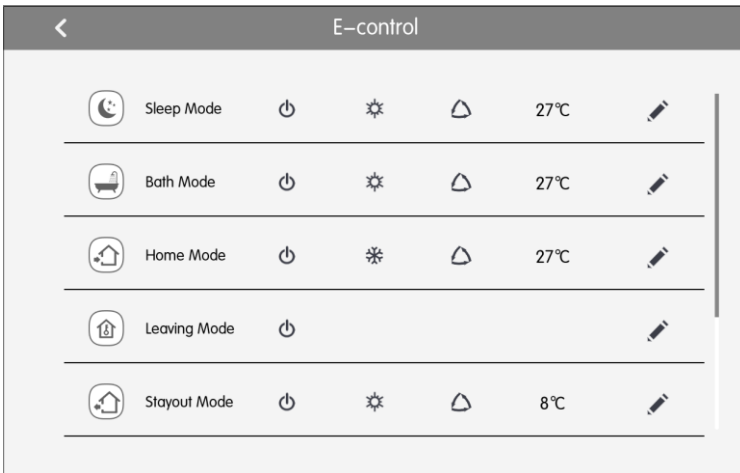



Fig.5.7 e-Control Page

(1) Turn on e-Control

Pressing the zone button can turn on the selected short-cut mode.

Note: e-Control can be turned on repeatedly. When it is turned on, centralized controller will send out one control order according to the mode setting.

(2) Edit e-Control

Press  to edit the mode parameters.

Settings of mode parameters are the same as single unit control.

After setting is done, press  to save the setting.

(3) Add equipment

On the edition page, press  and then the page of equipment selection will pop in.

User can set the indoor unit that works according to the current modes. Pressing the icon of indoor unit can select or cancel the unit. Press  to save the setting.

Note: For a same indoor unit, different modes can be set at the same time. In this case, indoor unit will work according to the latest energized mode.

(4) Restore default settings

On the edition page, press the “Reset Default” button to restore the ex-factory default settings.

Ex-factory default settings:

Mode	Subject	On/off	Mode	Set temp	Fan speed	Swing	Function
Sleep	All IDUs	On	Heat	27°C	Auto	Off	Turn on sleep function
Home	All IDUs	On	Cool	27°C	Auto	Off	--
Leaving	All IDUs	Off	--	--	--	--	--
Stayout	All IDUs	On	Heat	8°C	Auto	Off	Turn on the stay-out function
Bath	All IDUs	On	Heat	27°C	Auto	Off	--
DIY	All IDUs	On	Heat	27°C	Auto	Off	--

5.6 Group Control

Press the IDU button on the home page to enter the page of group function.

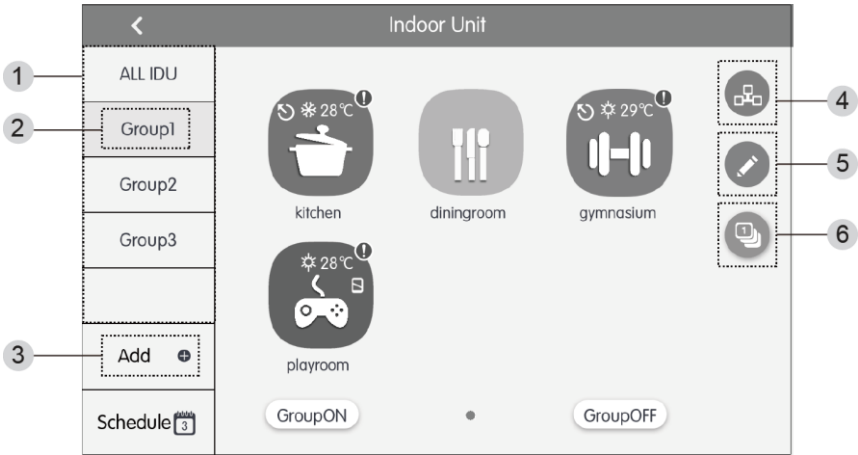







Fig.5.8 Group Page

No.	Name	Instructions
①	Group display	Display in separate page the list of groups that are controlled by the centralized controller. Sliding up or down can turn over the page.
②	Group names	Display the names of every group.
③	Add group button	Press the button to add a group.
④	Group control button 	Press the button to enter the group control page.
⑤	Group edit button 	Press the button to enter the group edit page.
⑥	IDU sort button 	Press the button to enter the group sort page.

(1) Group control

Press the  button to enter the page of group control. Control parameters are the same as single unit control.

Press button  to send out the group control order.

(2) Edit group

Press  to enter the page of group editing.

Use can set the group name and add indoor units to the group.

Press  to save the setting.

Note: 1 set of indoor unit can be set in up to 5 groups

(3) IDU sort

Press the  button to enter the IDU sort page.

Select one indoor unit, press the left of right button at the bottom of the screen to switch the display of the indoor units.

(4) Add group

Press the  button to add new groups. Then the page of group editing will pop in. User can set the group name and add indoor units to the group.

(5) Delete group

Press  to delete the selected group.

5.7 Schedule Management

Press Schedule button on the IDU home page to enter the page of schedule management.

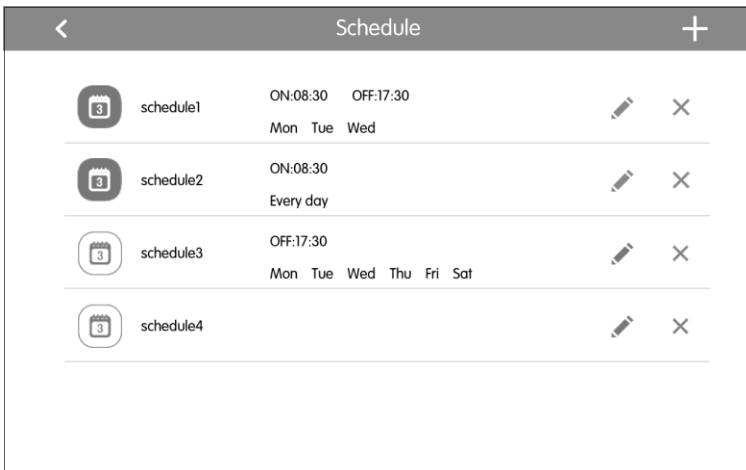

Fig.5.9 Schedule Home Page

(1) Open the schedule

Press the zone button to open or close the schedule.

When the icons and texts turn blue indicating the schedule is open.

When the icons and texts turn grey indicating the schedule is closed.

When schedule is open, centralized controller will send out the control order automatically according to the time and parameters set by the schedule.

(2) Edit schedule

Press  to enter the page of schedule editing.

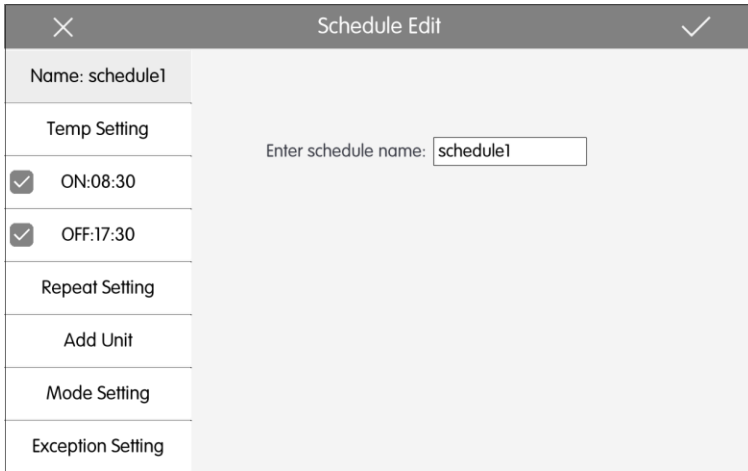

Schedule Edit	
Name: schedule1	Enter schedule name: <input type="text" value="schedule1"/>
Temp Setting	
<input checked="" type="checkbox"/> ON:08:30	
<input checked="" type="checkbox"/> OFF:17:30	
Repeat Setting	
Add Unit	
Mode Setting	
Exception Setting	

Fig.5.10 Page of Schedule Editing

Press  to save the schedule setting.

- 1) Setting method of schedule control parameters is the same with that of the single indoor unit control.
- 2) Add equipment

Press the “Add Unit” button to enter the page of equipment selection. User may set the indoor unit that works according to the current schedule.

Note: For a same indoor unit, different schedules can be set at the same time. In this case, unit will work according to the schedule setting that is previously energized.

- 3) Repeat schedule

Press “Repeat Setting” button to enter the setting page. User can set the schedule work repeatedly according to weeks.

- 4) Time setting

Press the “ON Time” or “OFF Time” button to enter the page of time setting.

User can set the time for unit to turn on/off automatically.

Note: The time to activate or stop unit can be set at the same time, but they must not be the same.

- 5) Add exception

Press the “Exception Setting” button to enter the setting page of schedule

exception.

The calendar will pop in, user can select the date to activate or cancel exception. Press ✓ to save the selected date.

Notes: When schedule exception has been set, air conditioner will not execute the control order on the exception date set by the schedule.

User may add several exception dates.

(3) Add schedule

Press + to add new schedules. Then the schedule editing page will pop in for user to set relevant parameters.

Note: User may add up to 28 schedules.

(4) Delete schedule

Press 🗑️ to delete the selected schedule.

5.8 Local Setting

Press Setting on the home page to enter the setting page.

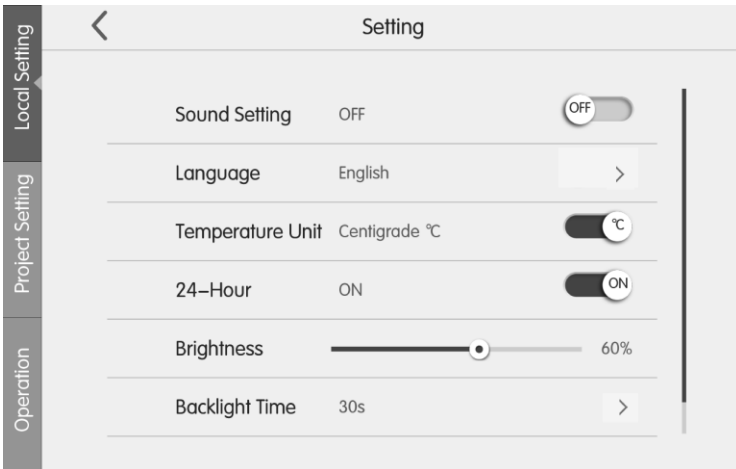

Fig.5.11 Setting Page

Press the “Local Setting” button to switch to the setting options of the current unit.

Select the needed option at the left side column. Sliding up and down can turn over the page.

Set the corresponding content at the right side.

Multi-VRF Centralized Controller

Local setting includes:

(1) Sound, temperature unit, time format, mutual exclusion

Press the button to select one kind of setting.

(2) Language

Press the button can select system language, such as English, Simplified Chinese or Traditional Chinese.

(3) Time setting

Set the date and time of the centralized controller system, can also set the VRF unit time if needed.

(4) User password

Press the button can activate or inactivate user password.

When password is activated, it can be set or changed in 4-10 numbers or characters. Original password is blank.

Press the button  to save the password.

Note: If user password is activated, user needs to input password to enter the control page when centralized controller is turned on or activated.

(5) Backlight setting

Pressing this button can set the timeout period of screen backlight. Screen will be shut off and the centralized controller will enter sleep mode when the timeout period is over.

Note: When centralized controller is in sleep mode, use can wake it up by touching any part of the touch screen or the touch button at the right bottom of the screen.

(6) Brightness

Pressing or dragging the sliding bar can adjust the backlight degree.

(7) Customer Service

User can set the name and phone number of the local customer service center for the convenience of acquiring immediate solutions and technical support.

Press the  button to save the setting.

(8) Restore default settings

Press the "Reset" button to restore local setting, e-Control setting, group setting, schedule setting, names and icons of indoor units, and other relevant ex-factory default settings.

- 1) When switching between indoor network and outdoor network, or reset unit IP, restore the ex-factory setting for centralized controller.
- 2) After debugging for the centralized controller is finished, connect in to the network. If connect the centralized controller to the network during debugging process, it needs to restore the defaulted ex-factory setting.
- (9) View Selecting

Press “View Selecting” ,Choose Room View or Device View.

5.9 Engineering Setting

On the home page, press setting to enter into setting interface.

Press the “Project Setting” button to switch to engineering setting, the operation method is the same as the setting of this unit.

(1) Indoor unit register

Enter into the indoor unit register interface, select the chosen indoor unit according to the displayed engineering No. of indoor unit icon, and then press  to save, it will display the registered indoor unit in the home page.

Notes: There are 32 sets of indoor units can be registered at most.

(2) Name&Icon setting

Switch to name&Icon setting interface to select the engineering No., and set the name and icon of indoor unit.

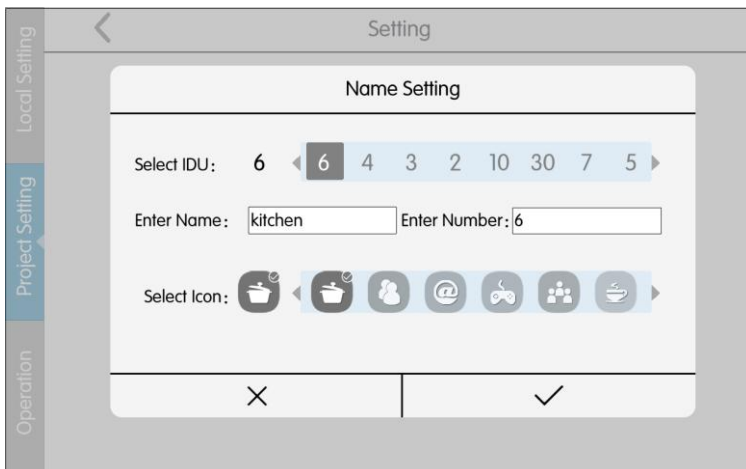

Fig. 5.12 Setting Page of Indoor Unit

Press the Engineering No. to select the required indoor unit that needs to be

set.

(1)Name: can input number or letter (it should not be over 10 letters)

(2)Icon: press to select the preset icon.

(3)Engineering No.: it can be set to be 1-255.

(4)Press  button to successfully save the setting. Then the indoor unit list in the home page will display the new name and icon of indoor units.

5.10 Operation Notice

Press Setting on the homepage to enter the setting page.

Press the “Operation” button to switch to operation notice. The operation method is the same with that of the local setting.

On the page of operation notice, user can view the information of the local unit, customer service information, operation instructions and other notices.

6 Room View

On homepage, click Setting-» Local setting -» View selection. Select room view and then enter room view homepage.

Note: Room View function provides from version V2.2.0.

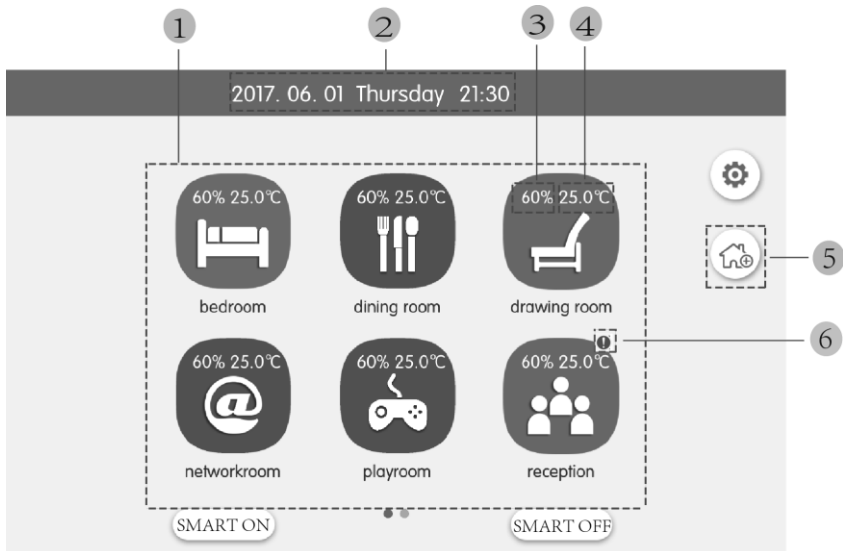

Fig. 6.1 Display Diagram of Room View Homepage

No.	Name	Instruction
1	Room selection zone	Click it to enter room control interface
2	Time display zone	Display current system date, week and time
3	Room set humidity icon	It is displayed when room smart switch is turned on, which indicates room set humidity
4	Room set temperature icon	It is displayed when room smart switch is turned on, which indicates room set temperature
5	Room adding button	Click this button to add rooms
6	Room Device Error Icon	Error icon will be displayed if at least one indoor unit is malfunctioning in the room.

6.1 All ON/OFF

Under room view homepage, press “SMART ON” button to turn on the smart switches of all rooms. Press “SMART OFF” button to turn off the smart switches of all rooms.

Note: When smart switch is turned off, indoor unit and fresh air keep original state.

6.2 Room Control

On room view homepage, click room icon to enter room control interface.

Press room icon for 5 seconds to pop up the room name, icon and room device selection settings.

Press “Room adding button” to add rooms. rooms quantity limit 16.

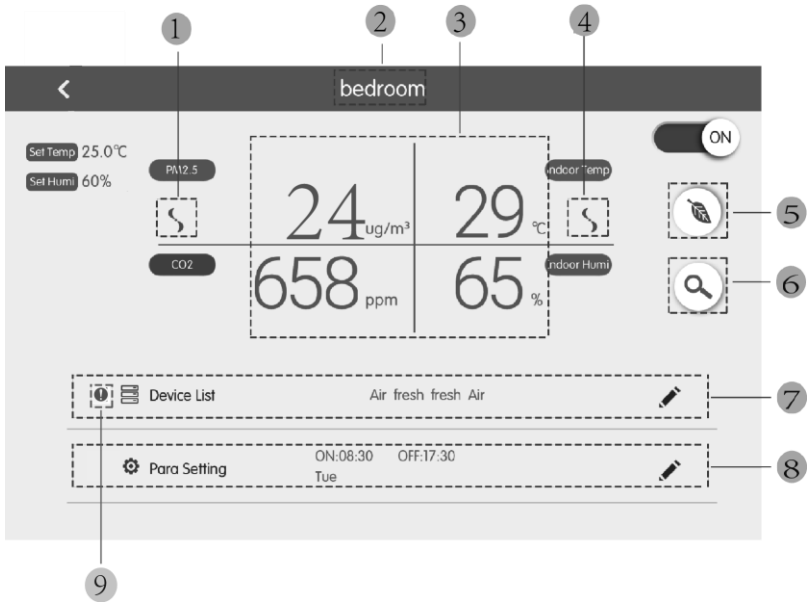

Fig. 6.2 Display Diagram of Room Control Interface

No	Name	Instruction
1	Curve view	Display the air state curve of the room in 24 hours
2	Energy-saving strategy button	<ul style="list-style-type: none"> ● Click this button to turn on or turn off energy-saving strategy ● Bright icon means energy-saving strategy is turned on; extinct icon means energy-saving strategy is turned off
3	Fan speed icon of fresh air unit	Display the fan speed of fresh air unit
4	Fan speed icon of air conditioner	Display the fan speed of air conditioner
5	Room name zone	Display current room name
6	Air parameter display zone	Display current PM2.5, CO ₂ , indoor temperature and indoor humidity, Note: Only the fresh air unit which is connected with air box can display the above values.
7	Device list zone	<ul style="list-style-type: none"> ● Display device name of this room ● Click Edit button to enter device selection interface and select indoor unit

8	Parameter setting zone	<ul style="list-style-type: none"> ● Display timer information of this room ● Click Edit button to enter parameter setting interface and then you can set the timer function of smart switch in this room ● Click Edit button to enter parameter setting interface and then you can set the temperature, humidity, fresh air fan speed and air conditioner fan speed in this room
9	Room Device Error Icon	Error icon will be displayed if at least one indoor unit is malfunctioning in the room.

6.2.1 Smart Switch

Click On/Off button to turn on or turn off the smart switch of this room.

When smart switch is turned on, it will turn on indoor unit and fresh air. It will send target temperature, humidity and fan speed to indoor unit. It will intelligently send specific mode to indoor unit according to indoor and outdoor temperature and set target temperature.

When smart switch is turned off, indoor unit and fresh air keep original state.

6.2.2 Room Energy-saving Strategy

Click energy-saving strategy button to turn on or turn off energy-saving strategy of this room.

When there are air conditioner and fresh air unit in the room, if smart switch and energy-saving strategy are turned on, it will intelligently send startup, stoppage and mode to the fresh air unit according to the operation status of air conditioner in the room, indoor and outdoor temperature and set target temperature.

When smart switch and energy-saving strategy are turned on, backstage will arrange detection automatically in every hour. When smart switch and energy-saving strategy are detected to be turned on, it will smartly resend specific mode, startup and stoppage to the fresh air unit according to the operation status of air conditioner in the room, indoor and outdoor temperature and set target temperature.

Note:

- ① When it is in energy-saving backstage detection, fresh air operation will be

valid after the detection. That is, when the status of fresh air unit is changed by other ways, it will not be controlled by the energy-saving strategy any more.

- ② The fresh air unit which is not connected with air box or the fresh air unit with auto mode invalid are not controlled by smart switch and energy-saving strategy.

6.2.3 Room Parameter Setting

Click “Parameter setting” button to enter the setting interface of room parameter.

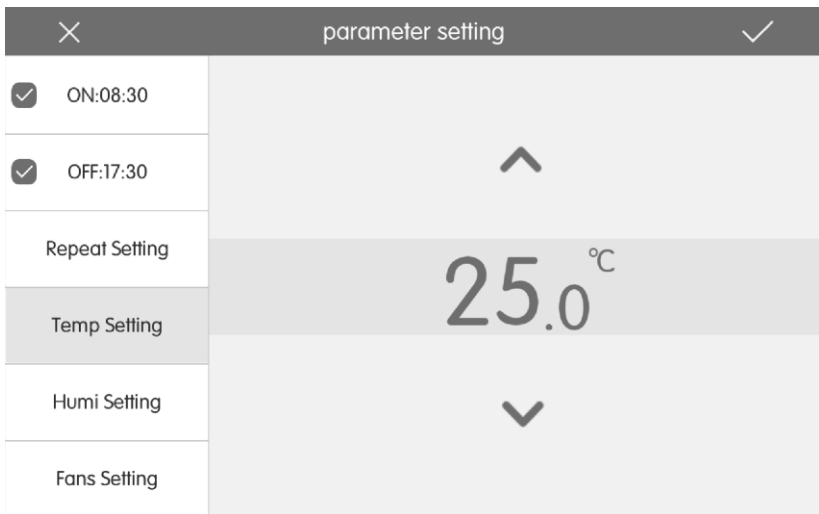

Fig. 6.3 Diagram of Room Parameter Setting

1) Time setting

Click “Unit on time” or “Unit off time” button to enter time setting page. You can set timer to turn on or turn off the smart switch in this room. Click in front of the button to turn on unit on time or unit off time.

Note: Unit on time and unit off time can be set simultaneously. But the set time shall be different.

2) Schedule repeat

Click “Repeat setting” button to enter setting page. You can set the schedule repeat time according to week.

3) Temperature setting

Click “Temperature setting” button to enter temperature setting page. You

can set target temperature of the room.

4) Humidity setting

Click “Humidity setting” button to enter humidity setting page. You can set target humidity of the room.

Note: Humidity setting is only available for the indoor unit with humidity adjustment function.

5) Fan speed setting

Click “Fan speed setting” button to enter fan speed setting page. You can set target fan speed of indoor unit and fresh air unit in this room.

6) Save setting

If smart switch is turned on, click ✓ button to send set target temperature, target humidity and target fan speed immediately; mode command will be sent intelligently according to indoor temperature, outdoor temperature and target temperature. If smart switch is turned off, click ✓ button to save relevant setting parameters.

6.2.4 Room Device List



Fig. 6.4 Page of Room Device List

Click “Device list” button to enter device list interface of the room.

In device list interface, click indoor unit icon to enter single unit control.

Press indoor unit icon for 5 seconds to pop up indoor unit name, project

number and icon settings.

Click “Adding” button to add device or delete device in this room.

Note: When Adding devices , it only allows to add air condition units and fresh air units which are connected with air box.

6.2.5 Air State Curve

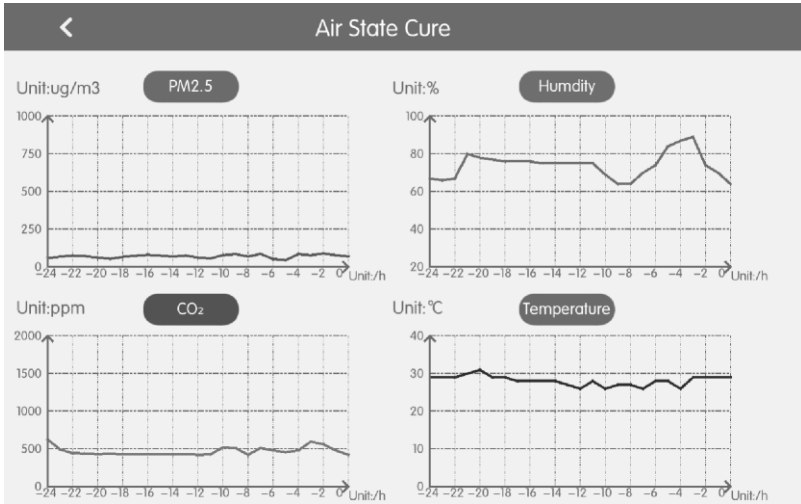

Fig.6.5 Page of Air State Cure

Click curve view button to enter air state curve interface. This interface will display the air state curve within 24 hours.

Note: Curve data sample will be taken every one hour. If the data sample in a certain moment is 0, the point corresponding to this moment is cut off and this point is discontinuous. This function is available only when the room adds the fresh air unit which is connected with air box.

The PM2.5 range is:0-1000ug/m³;The CO₂ range is:0-2000ppm ; The Temperature range is:0--40°C ; The Humidity range is: 20%-90%. if the parameter exceeds the mileage, it wills display the maximum and minimum values.



6617000013